

Clearing a Staple Jam

Clearing a Staple Jam of the 100-sheet Staple Finisher

- 1 **Open the finisher front cover 1.**



- 2 **Open the conveyor guide (D4).**

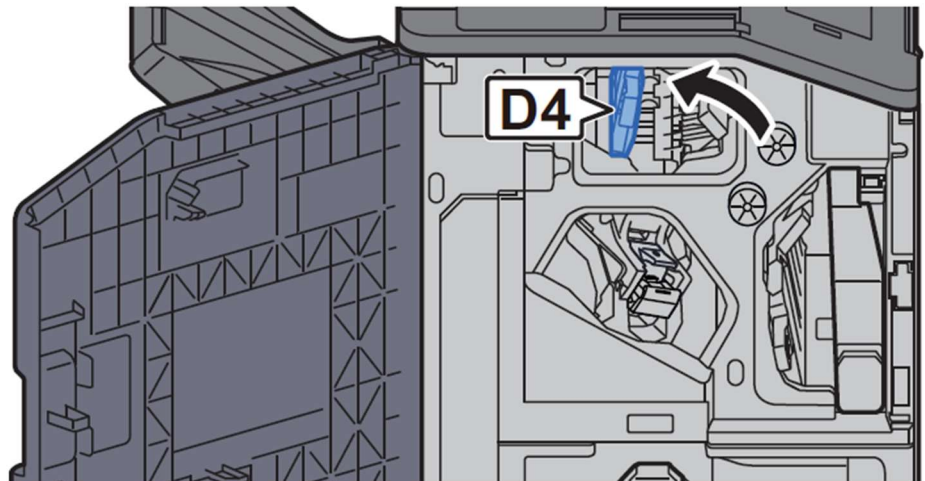

3 Turn knob (D5).

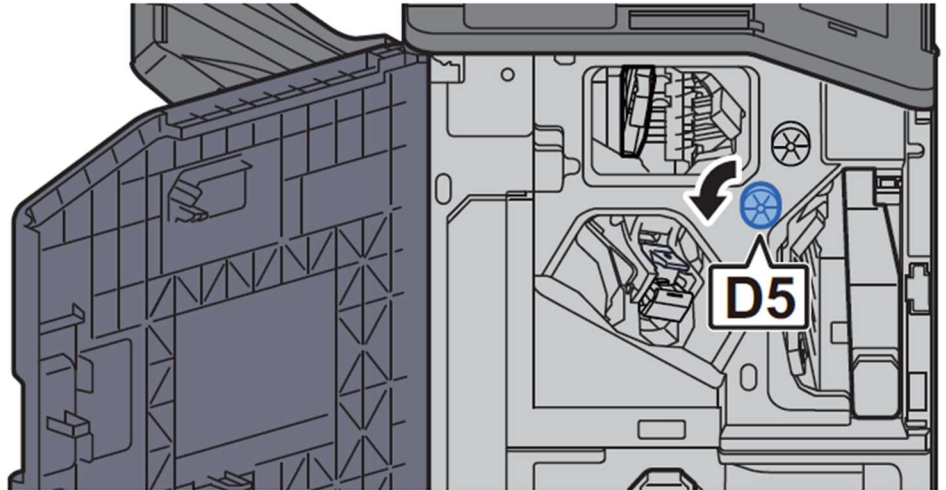

4 Remove any jammed paper.

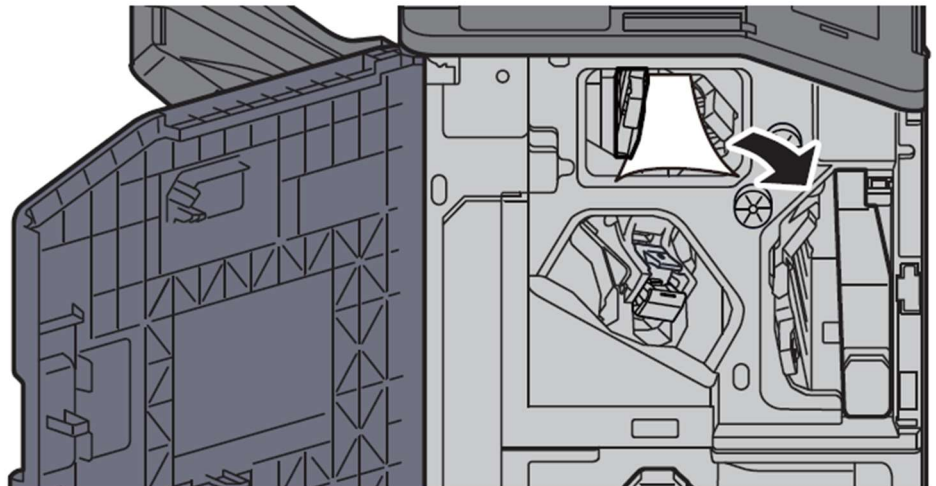

5 Return the conveyor guide (D4) to the original position.

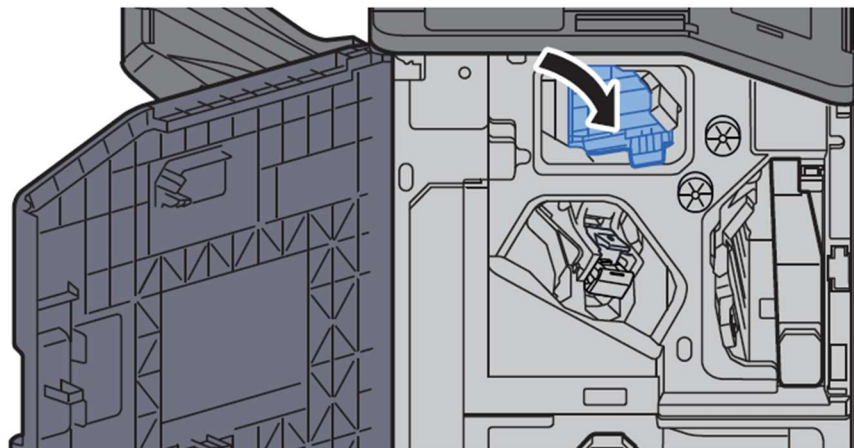

6 Remove the Staple Cartridge Holder (A).

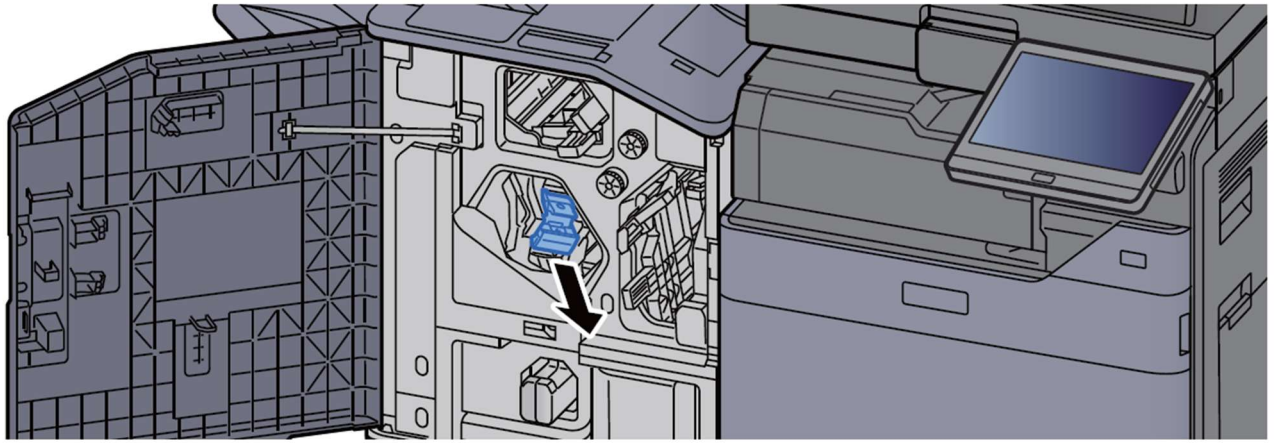

7 Remove the jammed staple.

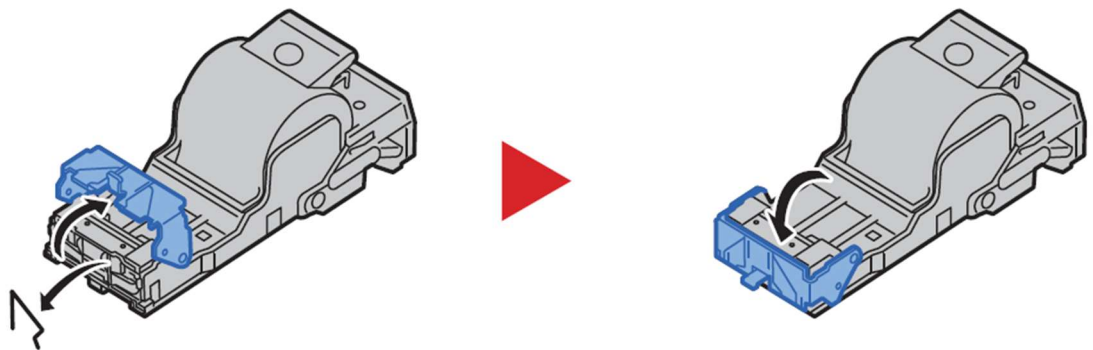

8 Install the Staple Cartridge Holder (A).

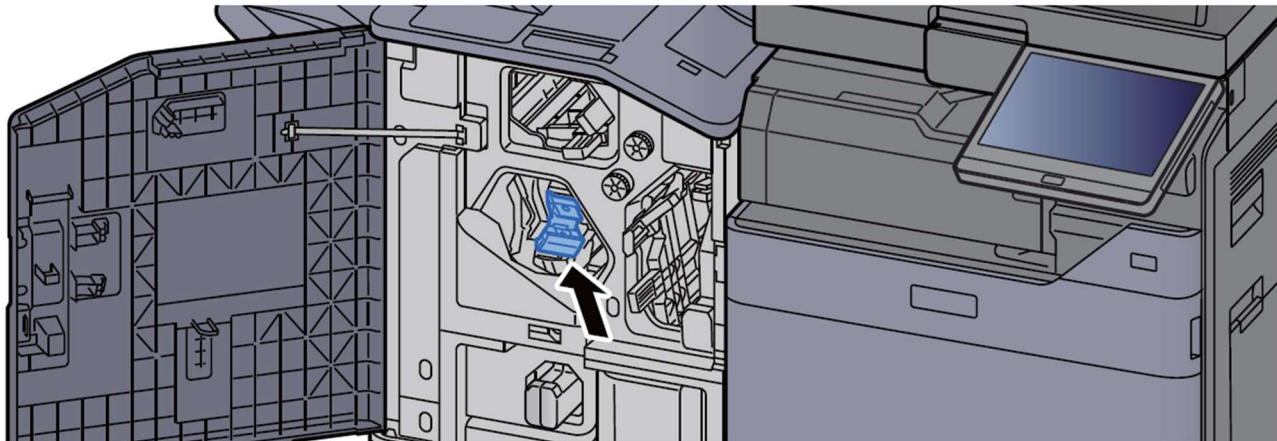

9 Return the cover to the original position.

